

**VOGEL**  
nábytek  
s.r.o.

**KŘESLA**

Nehoupeme s Vámi, my Vás pohoupeme.

platnost od 1.4. 2019

**VOGEL**  
nábytek  
s.r.o.



Novinky sety



R51 **FLAVIO**  
str.3



R52 **FILIP**  
str.3



R53 **FAUST**  
str.3



R61 **RADEK**  
str.5



R62 **RALF**  
str.5



R63 **RON**  
str.5



R71 **RIK**  
str.7



R72 **RAFAEL**  
str.7



R73 **ROLF**  
str.7

Set



R23 **DAG**  
str.9



R25 **DEV**  
str.9



R26 **DON**  
str.9

## Křesla pohupovací



R22 DENNY  
str.11



R23 DAG  
str.11



R19 DANÍK  
str.11



R34 ERIC  
str.13



R35 EMILIO  
str.13



R37 EVAN  
str.13



R17 BADY  
str.15



R18 BALLY  
str.15



R20 BENJI  
str.15

## Křesla pevná



R42 ORLANDO  
str.17



R43 OMAR  
str.17



R44 OSCAR  
str.17



R46 PEDRO  
str.19



R47 PAUL  
str.19

## Křeslo houpací



R24 MAX  
str.21



R21 MATÝS  
str.21



R56 RUDY  
str.19



R03 ALY  
str.23



R070 ADÁMEK  
str.23



R90 ALL  
str.23

dětské křesílko

## Křesla chromová



R59 TIMO  
str.25



R50 TITO  
str.25

- \* kostry křesel jsou z bukového dřeva s povrchovou úpravou
- \* na výběr ve standardu 4 barvy moření (ostatní za min. příplatek 20%)
- \* křesla mají kvalitní prošivané, ergonomické sedáky
- \* k čalounění je na výběr 120 látek
- \* součástí některých křesel jsou snímatelné (pratelné) područky R-navleky
- \* chromová křesla (chrom 3-5mikronů, nikl 12-15mikronů)
- \* nosnost křesel je 120kg



křeslo v provedení R51-DS-504 **R51** FLAVIO



křeslo v provedení R52-DS-502 **R52** FILIP  
nosnost 240kg

*novinky*



křeslo v provedení R53-DS-505 **R53** FAUST  
nosnost 360kg

**RANGER** (ukázka látek)  
100% polyester / 440g/m<sup>2</sup> / 45 000 cyklů



Provedení  
**STANDARD**  
MASIV BUK



**DS**  
dub sonoma



**P**  
přírodní



**L**  
olše



**H**  
hnědá

Provedení  
**PŘÍPLATEK**  
20%



**DB**  
dub bordeaux



**T**  
třešeň



**HE**  
merano



**M**  
mahagon



**W**  
wenge

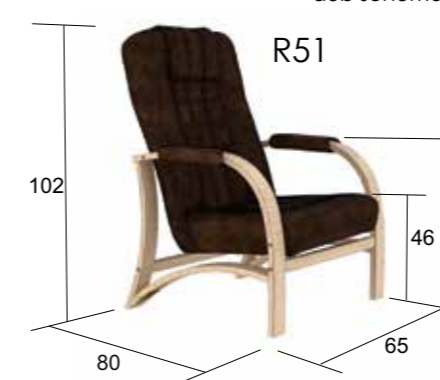



křeslo v provedení R61-DS-514 **R61** RADEK



křeslo v provedení R62-DS-515 **R62** RALF  
nosnost 240kg

*novinky*



křeslo v provedení R63-DS-516 **R63** RON  
nosnost 360kg

**ARTEMIS** (ukázka látek)  
100% polyester / 480g/m<sup>2</sup> / 45 000 cyklů



Provedení  
**STANDARD**  
MASIV BUK

**DS**  
dub sonoma

**P**  
přírodní

**L**  
olše

**H**  
hnědá

Provedení  
**PŘÍPLATEK**  
20%

**DB** dub  
bordeaux

**T** třešeň

**HE** merano

**M** mahagon

**W** wenge

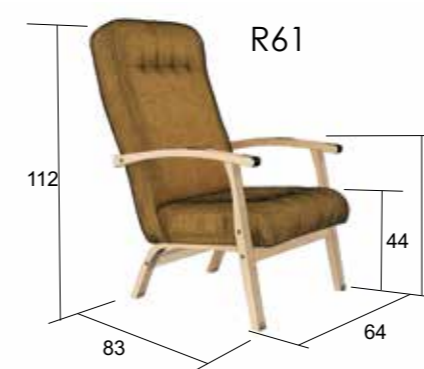



křeslo v provedení R71-DS-537 **R71** RIK  
nosnost 130kg



křeslo v provedení R72-DS-536 **R72** RAFAEL  
nosnost 240kg

*novinky*



křesla tohoto typu mají  
ROBUSTNĚJŠÍ KONSTRUKCI  
kostra 7,5cm



křeslo v provedení R73-DS-538 **R73** ROLF  
nosnost 360kg

**OLYMP** (ukázka látek)  
100% polyester / 460g/m<sup>2</sup> / 45 000 cyklů



Provedení  
**STANDARD**  
MASIV BUK



Provedení  
**PŘÍPLATEK**  
20%





**R023** FIXACE

ke křeslu lze přimontovat fixaci, ta zvýší pevnost a nosnost křesla až na 150 kg (křeslo se z pohupovacího změni na zcela stabilní)



křeslo v provedení R23-P-615

**R23** DAG



křeslo v provedení R25-P-616

**R25** DEIV

nosnost 240kg



křeslo v provedení R26-P-617

**R26** DON

nosnost 360kg

**EAST** (ukázka látek)  
100% polyester / 233 g/m<sup>2</sup> / 20 000 cyklů



Provedení  
**STANDARD**  
MASIV BUK



Provedení  
**PŘÍPLATEK 20%**

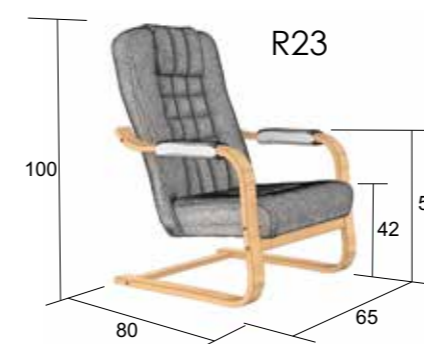



křeslo v provedení R22-P-519 **R22** DENNY



**R023** FIXACE křeslo v provedení R23-P-520 **R23** DAG

ke křeslu lze přimontovat fixaci, ta zvýší pevnost a nosnost křesla až na 150 kg (křeslo se z pohupovacího změnilo na zcela stabilní)



křeslo v provedení R19-P-521 **R19** DANÍK



**ARTEMIS** (ukázka látek)  
100% polyester / 480g/m<sup>2</sup> / 45 000 cyklů

Provedení  
**STANDARD**  
MASIV BUK



Provedení  
**PŘÍPLATEK**  
20%

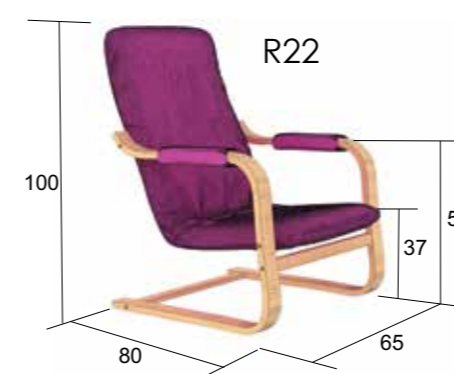
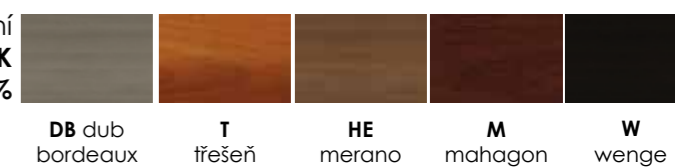

křeslo R19 lze pomocí šroubu zařizovat v libovolné poloze (při polohování doporučujeme na křesle nesedět)







křeslo v provedení R34-L-573

**R34** ERIC



křeslo v provedení R35-L-574

**R35** EMILIO



křeslo v provedení R37-L-576

**R37** EVAN

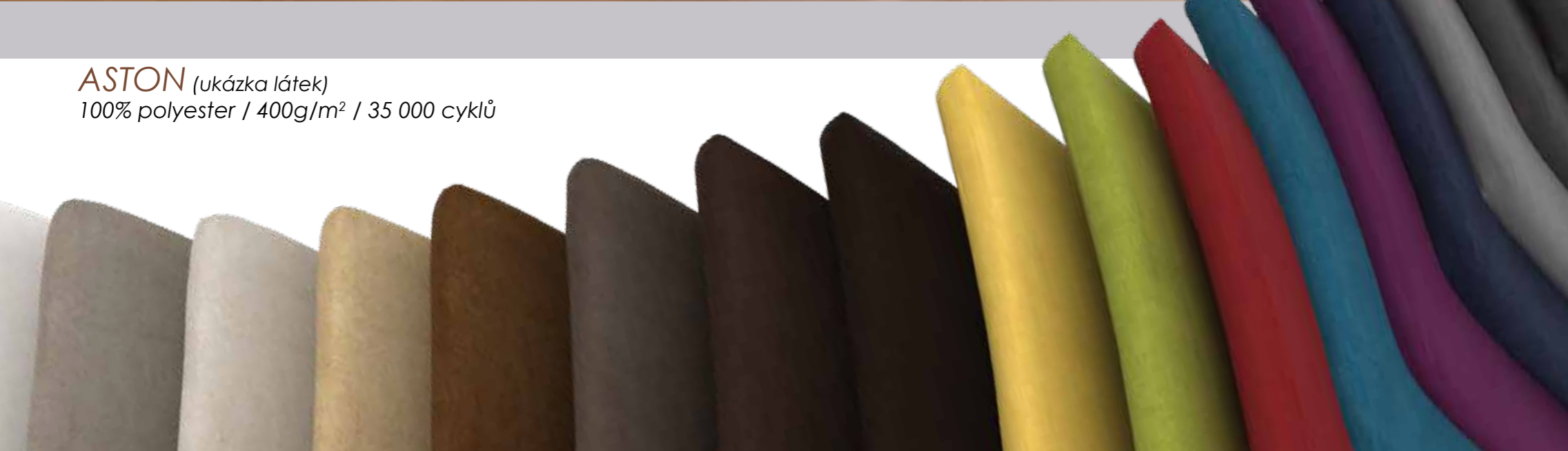

**ASTON** (ukázka látek)  
100% polyester / 400g/m<sup>2</sup> / 35 000 cyklů

Provedení  
**STANDARD**  
MASIV BUK



Provedení  
**PŘÍPLATEK**  
20%

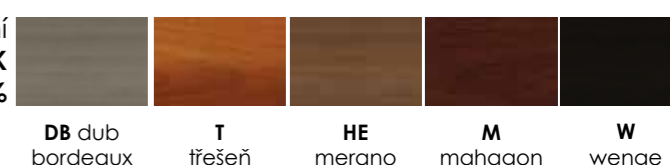

křeslo R37 lze pomocí šroubu zafixovat v libovolné poloze (při polohování doporučujeme na křesle nesedět)





křeslo v provedení R17-H-605 **R17** BADY



křeslo v provedení R18-H-600 **R18** BALY



křeslo v provedení R20-H-601 **R20** BENJI



**WEST** (ukázka látek)  
100% polyester / 238g/m<sup>2</sup> / 20 000 cyklů



Provedení  
**STANDARD**  
MASIV BUK



Provedení  
**PŘÍPLATEK**  
20%

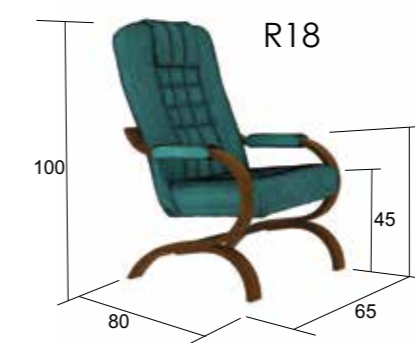

křeslo R20 lze pomocí šroubu zařizovat v libovolné poloze (při polohování doporučujeme na křesle nesedět)





křeslo v provedení R42-L-534

**R42** ORLANDO



křeslo v provedení R43-L-535

**R43** OMAR



křeslo v provedení R44-L-536

**R44** OSCAR



**OLYMP** (ukázka látek)  
100% polyester / 460g/m<sup>2</sup> / 45 000 cyklů

Provedení  
**STANDARD**  
MASIV BUK



Provedení  
**PŘÍPLATEK 20%**

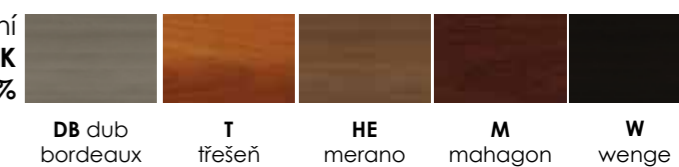

R42



R43



R44

křeslo R44 lze pomocí šroubu zařizovat v libovolné poloze (při polohování doporučujeme na křesle nesedět)





křeslo v provedení R46-DS-075 **R46** PEDRO



křeslo v provedení R47-DS-085 **R47** PAUL



podnožka v provedení R56-DS-080 **R56** RUDY  
nosnost 80kg

**TRINITY** (ukázka látek)  
100% polyester / 355 g/m<sup>2</sup> / 45 000 cyklů



Provedení  
**STANDARD**  
MASIV BUK



Provedení  
**PŘÍPLATEK**  
20%

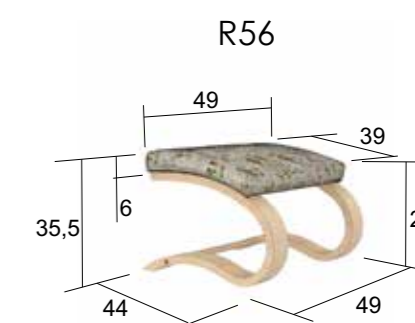
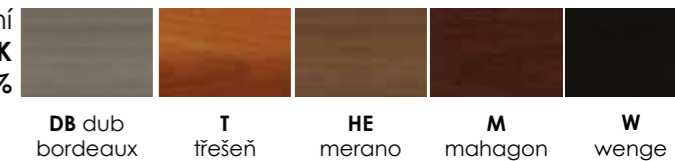



křeslo v provedení R24-H-060 **R24** MAX  
nosnost 140kg



podnožka v provedení R21-H-070 **R21** MATÝS  
nosnost 100kg

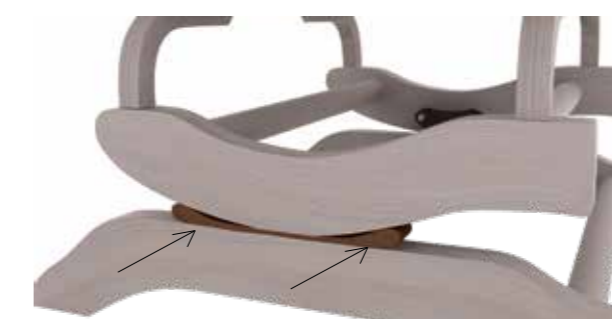

Zarážka k houpacímu křeslu R24 slouží k fixaci houpacího křesla. Zarážka se vsune mezi dílce, křeslo se tím zafixuje a nehoupe se.



**R024** ZARÁŽKA

**TRINITY** (ukázka látek)  
100% polyester / 355g/m<sup>2</sup> / 45 000 cyklů



Provedení  
**STANDARD**  
MASIV BUK



Provedení  
**PŘÍPLATEK**  
20%

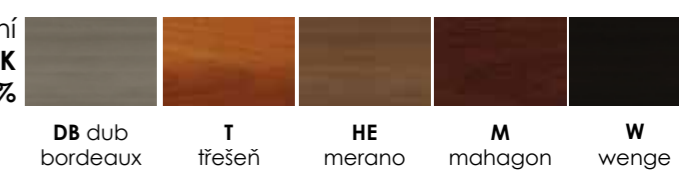



nosnost 110kg

křeslo v provedení R03-S-022

**R03** ALY

pouze v těchto látkách



nosnost 30kg

podnožka v provedení R90-S-023

**R90** ALL

pouze v těchto látkách



nosnost 50kg

křeslo v provedení R070-S-028



**R070** ADÁMEK

pouze v těchto látkách



*dětské křesílko*

Provedení  
**KOSTRY**  
masiv bříza



LÁTKA 021,023, 024, 027, 028 (ukázka látek)  
65% polyester, 35% bavlna / 108g/m<sup>2</sup>

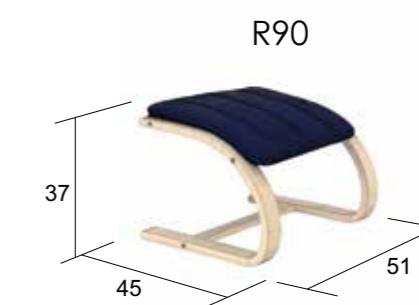



**CORSIKA** (ukázka látek)  
koženka 79% PVC, 19% PES, 2% PU  
600g/m<sup>2</sup> / 120 000 cyklů



zarážka proti překlopení  
(tvrzená guma)

křeslo v provedení R59-P-248

**R59** TIMO



křeslo v provedení R50-P-245

**R50** TITO



*retro styl*  
(do vyprodání)

Provedení  
**KOSTRY**



chrom

Provedení  
**PODRUČEK**  
u křesel R59, R50



DS  
dub sonoma

P  
přírodní

L  
olše

H  
hnědá

chromová křesla  
(chrom 3-5mikronů, nikel 12-15mikronů)



R59



R50

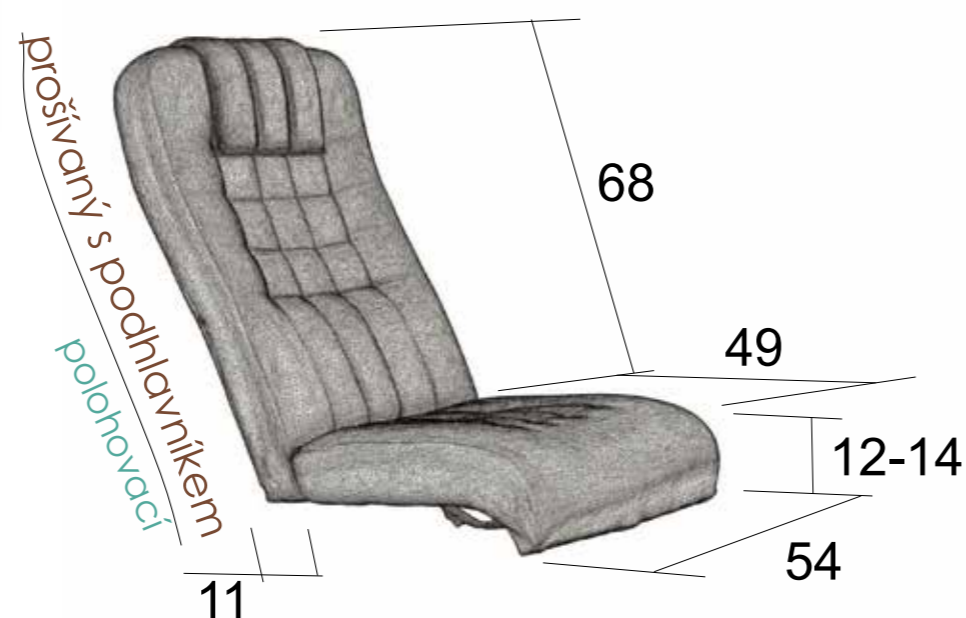
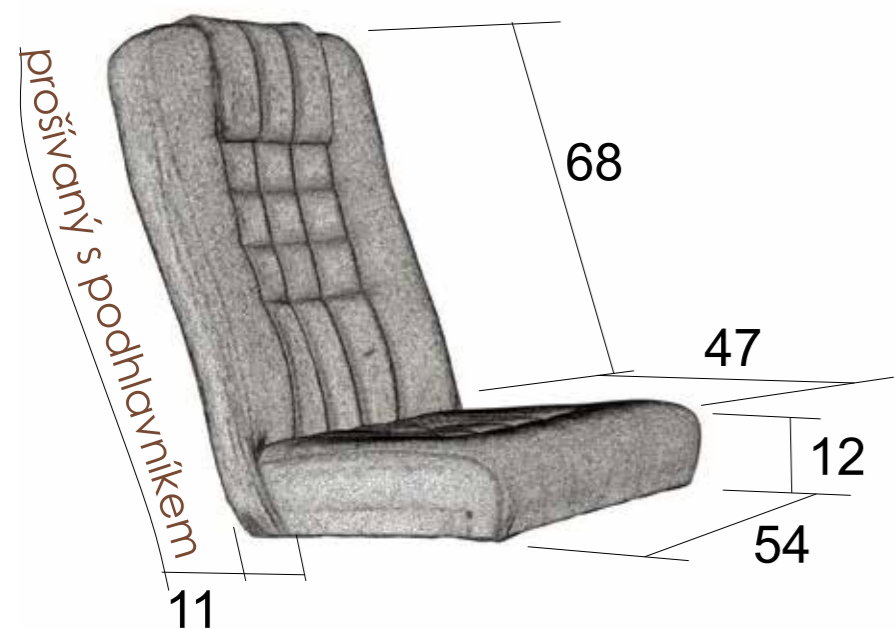
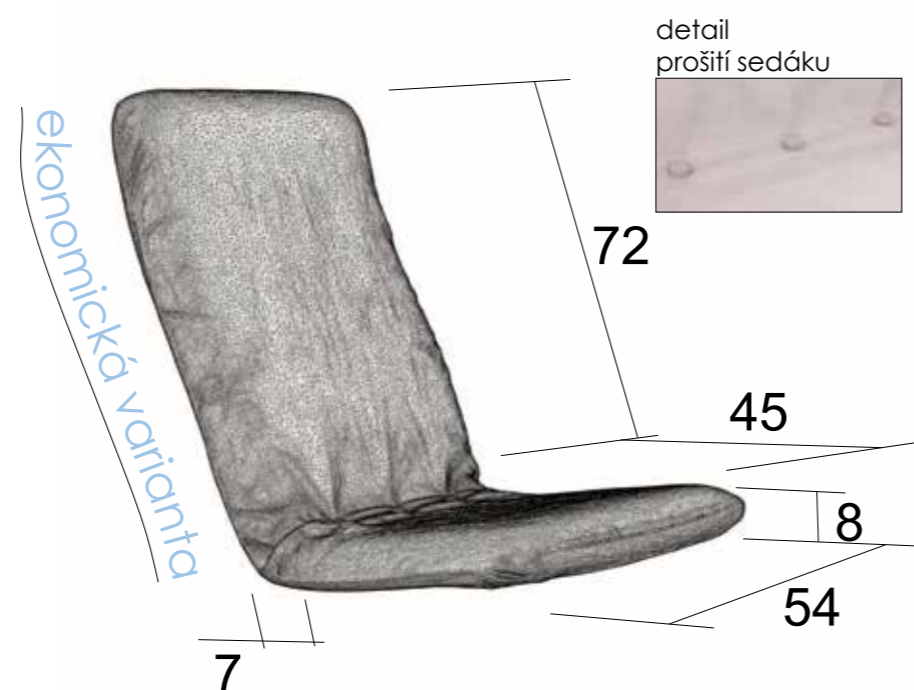
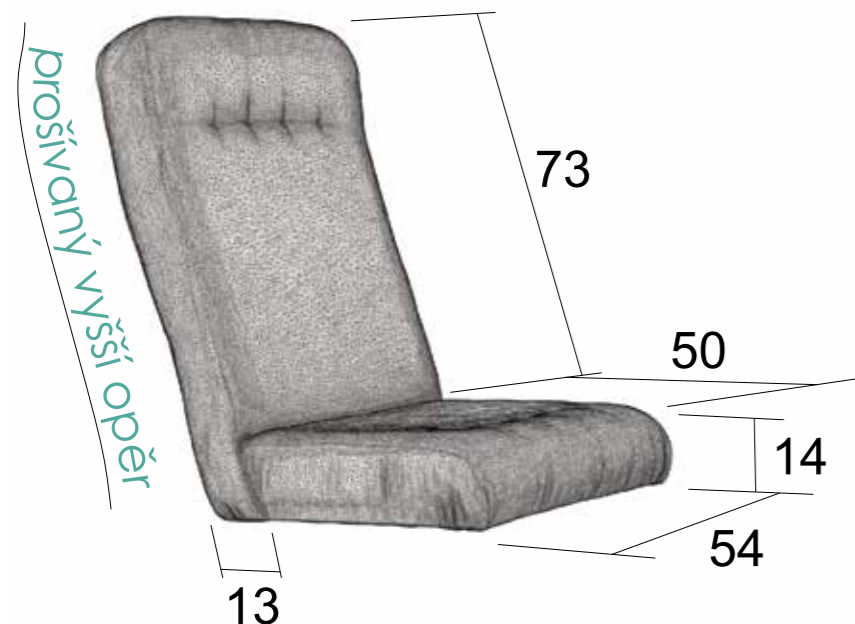

průřez sedákem křesla R23

- látka
- molitan 1,5cm
- molitan 3cm
- molitan 4cm
- geotextilie černá
- kovová konstrukce
- molitan 8cm
- dřevěný hranolek 2cm



- \* kostry křesel jsou z bukového dřeva s povrchovou úpravou
- \* na výběr ve standardu 4 barvy moření (ostatní za min. příplatek 20% )
- \* křesla mají kvalitní prošivané, ergonomické sedáky
- \* k čalounění je na výběr 120 látek
- \* součástí některých křesel jsou sňmatelné (pratelné) područky R-navleky
- \* chromová křesla (chrom 3-5mikronů, nikl 12-15mikronů)
- \* nosnost křesel je 120kg

### Nevybrali jste si?

Mimo naši klasickou nabídku křesel se můžete nechat okouzlit a inspirovat nabídkou křesílek zařazených v sortimentu židlí a sedaček.

Křesla a křesílka mají v našich obydlích mnoho funkcí. Slouží k pohodlnému sezení, relaxačnímu odpočinku a mimo jiné plní funkci designového prvku.





### vzorník látek



### RETRO Do vyprodání

100% polyester / 230g/m<sup>2</sup> / 30 000 cyklů

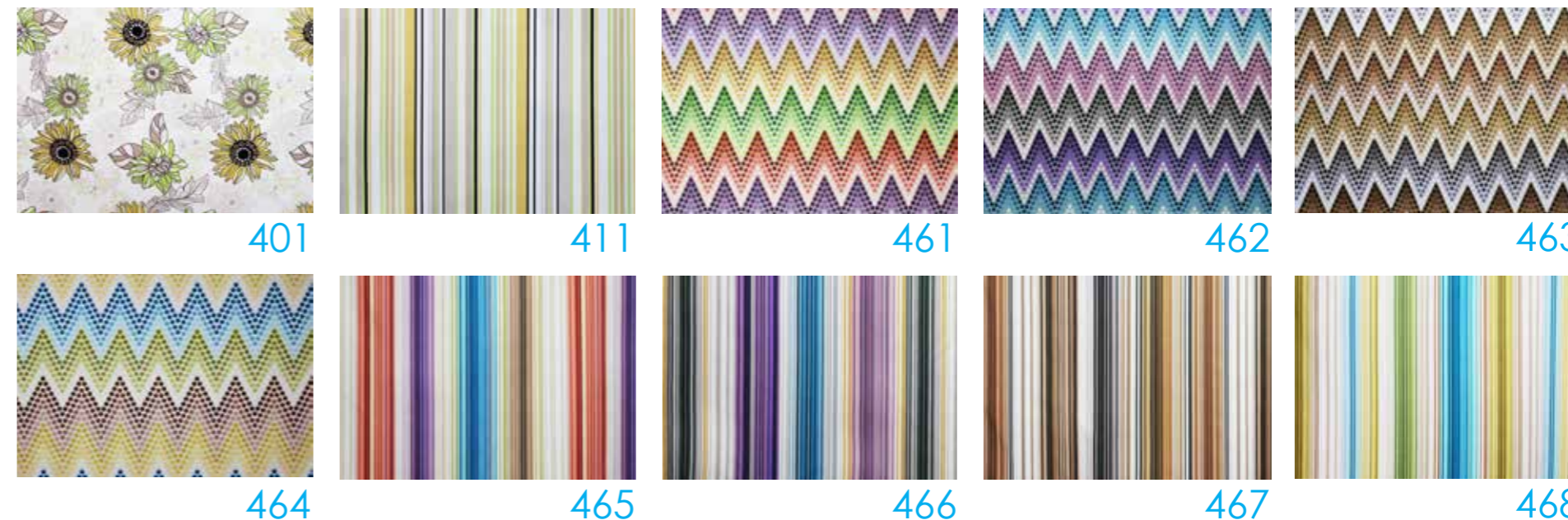

### moření bukových koster STANDARD



**DS**  
dub sonoma

**P**  
přírodní

**L**  
olše

**H**  
hnědá

### moření bukových koster PŘÍPLATEK min 20%



**DB**  
dub  
bordeaux

**T**  
třešeň

**HE**  
merano

**M**  
mahagon

**W**  
wenge

Jiná moření koster je možná po domluvě s asistentkou za minimální příplatek 20%  
Možnost objednání sedáků ve vlastní látce.  
Náhledy barevných provedení křeslíků se můžou tiskem mírně lišit.  
Rozměry křeslíků se mohou díky vylepšení kvality, designu, látky a prošití mírně odchýlovat +/- 3cm.

### CORSIKA

koženka 79% PVC / 19% PES, 2% PU / 600 g/m<sup>2</sup> / 120 000 cyklů



**RANGER**

100% polyester / 440g/m<sup>2</sup> / 45 000 cyklů



**ARTEMIS**

100% polyester / 480g/m<sup>2</sup> / 45 000 cyklů

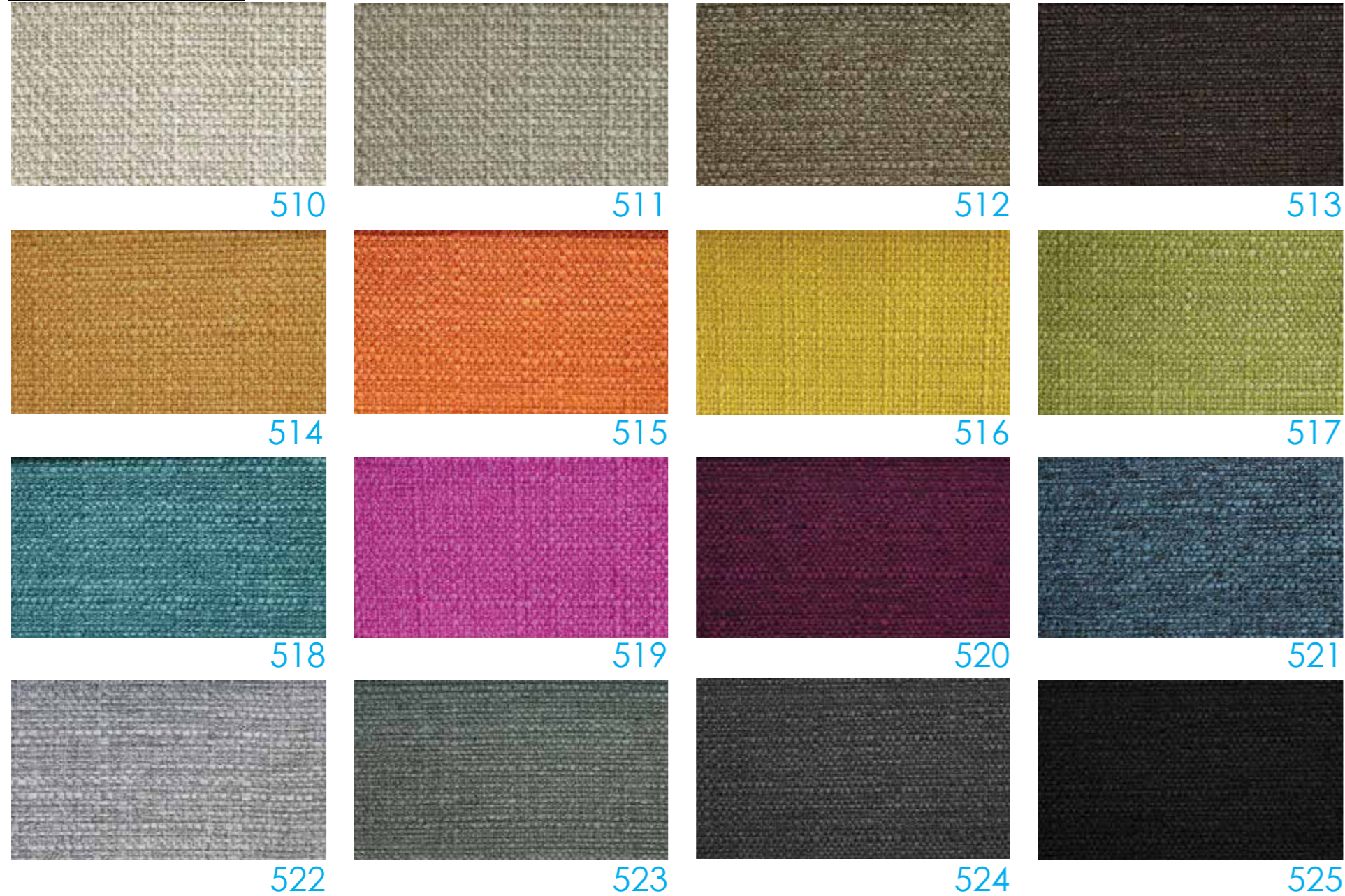

**OLYMP**

100% polyester / 460g/m / 45 000 cyklů

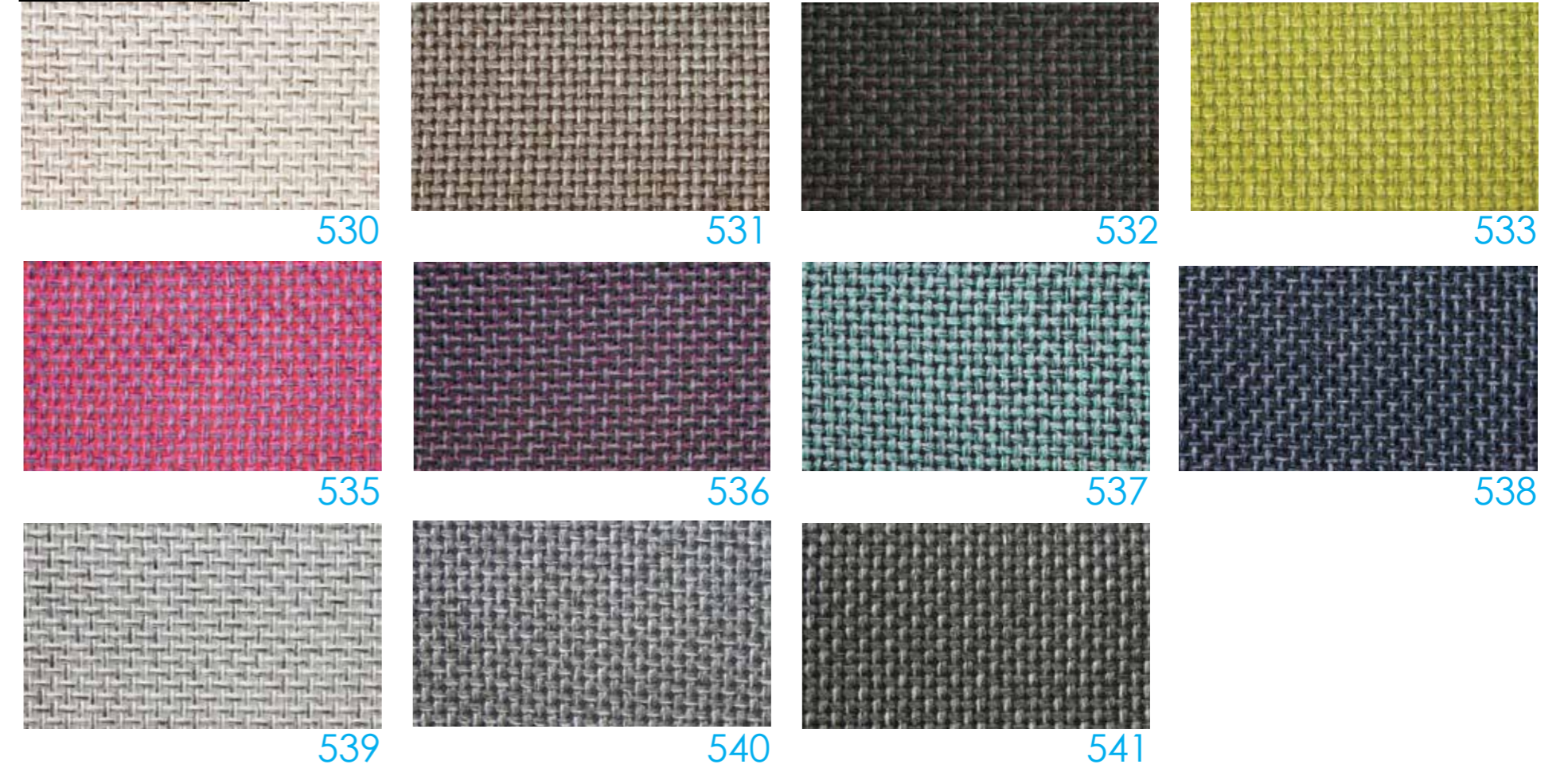

**TRINITY**

100% polyester / 355g/m<sup>2</sup> / 45 000 cyklů



## ASTON

**VOGEL**  
nábytek  
s.r.o.

100% polyester / 440g/m<sup>2</sup> / 35 000 cyklů



**vodě odolný  
MAXI clean**

## WEST antibakteriální

100% polyester / 238g/m<sup>2</sup> / 20 000 cyklů



**VOGEL**  
nábytek  
s.r.o.

## EAST antibakteriální

100% polyester / 233g/m<sup>2</sup> / 20 000 cyklů

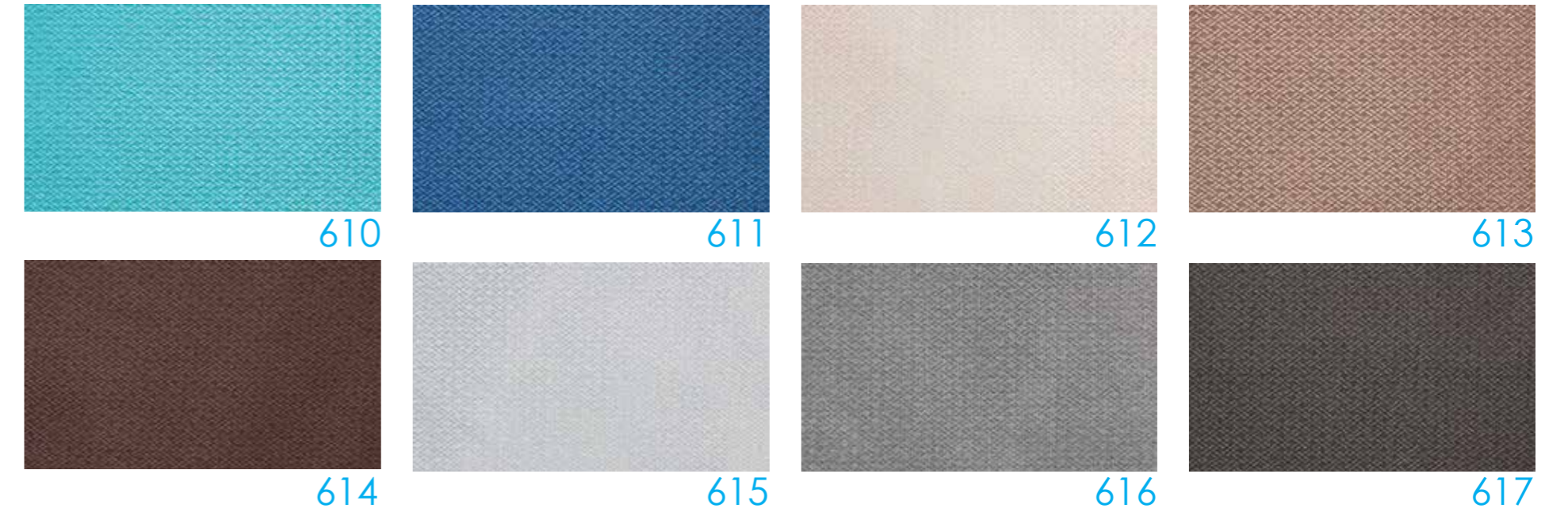

## TRINITY

100% polyester / 355 g/m<sup>2</sup> / 45 000 cyklů

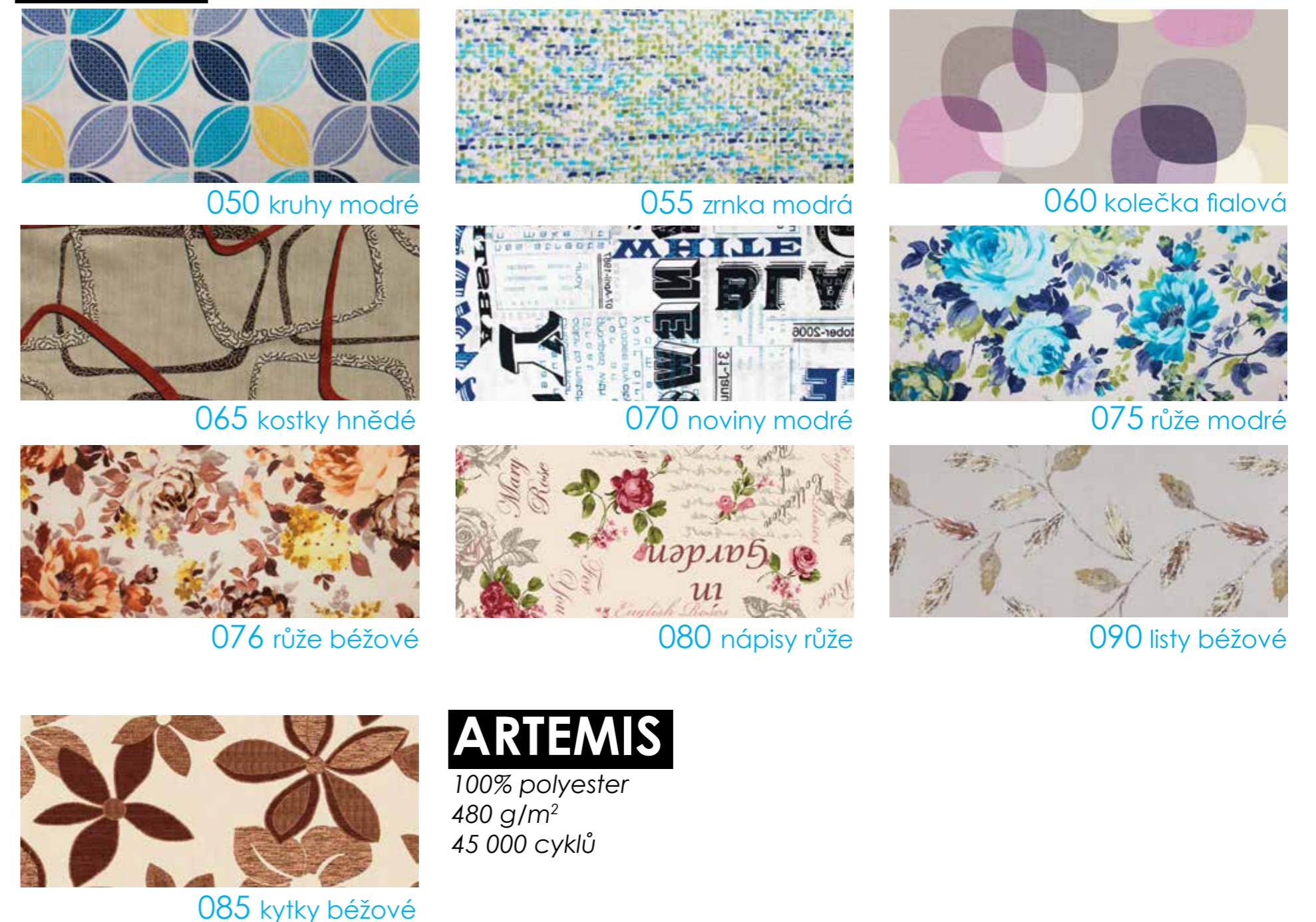

## ARTEMIS

100% polyester  
480 g/m<sup>2</sup>  
45 000 cyklů

Náhledy barevných provedení se můžou tiskem mírně lišit.  
Rozměry křesítek se mohou díky vylepšení kvality, designu, látky a prošití mírně odchylovat +/- 3cm.  
Vyhrazuujeme si právo na tiskové chyby.